

L&E
BEYOND

Mini Catalogue

2026



THETA R

PAGE 4-5



ALPHA T

PAGE 6-7



LAMPDA 2000

PAGE 8-9



ZETA 100 i

PAGE 10-11



L&E
BEYOND

THETA R LED MOVING SPOT WASH RECESSED

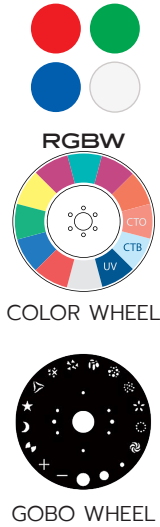

- Recessed moving spot 30W, wash 6 x 8w
- Spot 10° with Color wheel and Gobo wheel
- Wash 30 deg with RGBW

APPLICATIONS

Club, Bar, Restaurant, Hotel, Mall

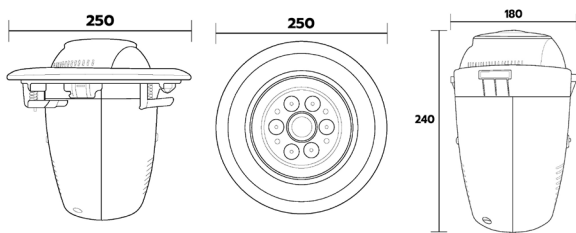
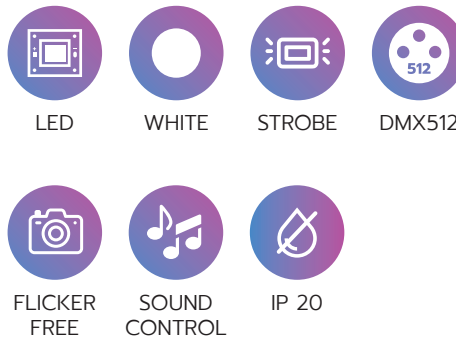

SPECIFICATIONS

Housing :	ABS Plastic
Finishing :	Black, White
Power Consumption :	80W
Operating Voltage :	100-250 V , 50 Hz
Power Connection :	Cable with plug
Signal Connection :	RJ45 Connector IN/OUT
IP Rating :	20
Weight (kg) :	2.2 kg
Size (WxHxD) :	160 x 160 x 229 mm
Source :	LED – White - 30W (Spot) LED – 4in1 - 6x8W (Wash)
Lamp Color :	White + 1 color wheel (Spot), RGBW (Wash)
Beam Angle :	10° (Spot), 35° (Wash)
Control Gear :	Built-in driver
Control Mode :	DMX512, RDM, Master/Slave, Auto Programs, Sound
Features :	Dimmer, Color Mixing(Wash), Color Wheel(Spot), Gobo Wheel, Strobe, Pan, Tilt, Flicker-free
DMX Channels :	13, 20 CH
Accessories:	RL45 to XLR 3 pin cable adaptor , Safety sling (Included)

ALPHA T



3200-8000K

LED PAR 200W TUNABLE WHITE

- LED COB 200W
- 3200-8000K
- Video flicker-free

APPLICATIONS

Stage, Studio, Events, Theatre, Concert, Club, Bar, Restaurant, Hotel, Mall



LED



WHITE



STROBE



FIX BEAM



FLICKER FREE



DMX512



SOUND CONTROL



IP 20

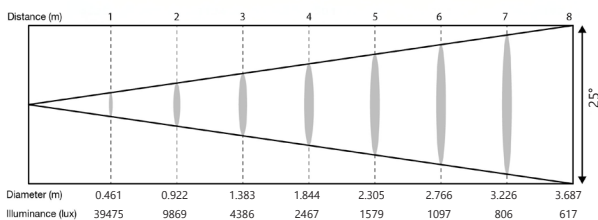
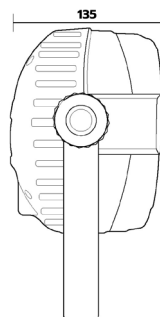
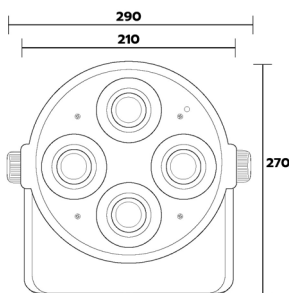

SPECIFICATIONS

Housing :	Die-cast Aluminium
Finishing :	Black
Power Consumption :	205W
Operating Voltage :	90-260 V , 50-60 Hz
Power Connection :	Powercon IN/OUT
Signal Connection :	XLR 3 Pin IN/OUT
IP Rating :	20
Weight (kg) :	2.46 kg
Size (WxHxD) :	214 x 140 x 169 mm
Source :	LED – COB - 4x50W
Lamp Color :	3200-8000K
CRI :	91
Beam Angle :	25°
Control Gear :	Built-in driver
Control Mode :	DMX512, Auto Programs, Sound
Features :	Dimmer, CCT, Strobe, Flicker-free
DMX Channels :	7, 15 CH
Accessories :	Safety sling (Included)



LAMPDA 2000



RGB



PATTERN
SELECTED

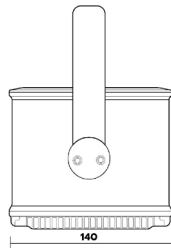
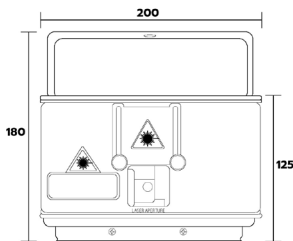

LASER 2W RGB

- Laser 2W
- RGB
- Pattern, Pattern Rotated, Pattern Size

APPLICATIONS

Stage, Events, Concert, Club, Bar



LASER



STROBE



DMX512



SOUND
CONTROL



STAND
ALONE



IP 20

SPECIFICATIONS

Housing :	Die-cast Aluminium
Finishing :	Black
Power Consumption :	20W
Operating Voltage :	100-240 V , 50-60 Hz
Power Connection :	Powercon IN/OUT
Signal Connection :	XLR 3 Pin IN/OUT
IP Rating :	20
Weight (kg) :	2 kg
Size (WxHxD) :	170 x 180 x 200 mm
Source :	red wavelength; 638nm-500mw green wavelength; 520nm-500mw blue wavelength; 445nm-1w
Lamp Color :	RGB
Beam Angle :	60°
Control Gear :	Built-in driver
Control Mode :	DMX512, Auto Programs, Sound
Features :	Dimmer, Color select, Strobe, Pattern, Pattern Rotated, Pattern Size
DMX Channels :	13, 18 CH
Accessories :	Safety sling (Include)



ZETA 100 i

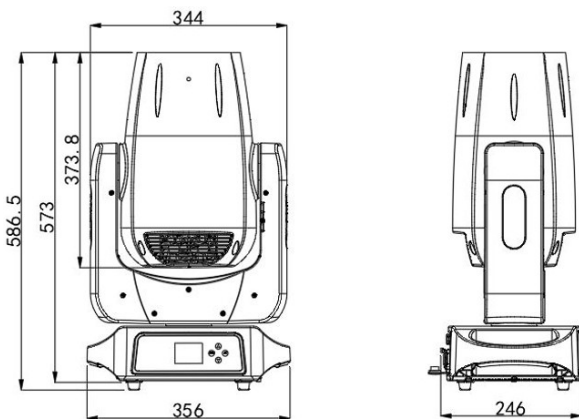

LASER MOVING 100W IP

- Moving Beam 100W
- Fix Beam 2°
- Outdoor

APPLICATIONS

Stage, Studio, Events, Theatre, Concert, Club, Bar, Restaurant, Hotel, Mall



SPECIFICATIONS

Housing :	Die-cast Aluminium
Finishing :	Black
Power Consumption :	180 W
Operating Voltage :	100-240 V , 50-60 Hz
Power Connection :	Powercon IP IN/OUT
Signal Connection :	XLR 5 Pin IN/OUT
IP Rating :	66
Weight (kg) :	24 kg
Size (WxHxD) :	356 x 246 x 586.5 mm
Source :	LED – laser - 100W
Lamp Color :	White + 1 color wheel + CMY
Beam Angle :	0.9°
Control Gear :	Built-in driver
Control Mode :	DMX512, RDM, Auto Programs, Master/Slave
Features :	Dimmer, Color Wheel, Gobo Wheel, Strobe, Prism, Pan, Tilt, Flicker-free, Focus, Frost, CMY
DMX Channels :	20, 23 CH
Accessories :	Brackets, Safety sling (Included)

ACCESSORIES



TRUSS CLAMP

SPECIFICATIONS

Material : Aluminium
Finishing : Sliver, Black
Pipe sizes : 48-51 mm
Max weights : 100 kg
Size (mm) : 83.6 x 58.3 x 30 mm



C-CLAMP

SPECIFICATIONS

Material : Aluminium
Finishing : Sliver, Black
Pipe sizes : 40-60 mm
Max weights : 30 kg
Size (mm) : 122.9 x 89.9 x 25.9 mm



SAFETY SLING

SPECIFICATIONS

Material : Stainless steel
Finishing : Sliver
Max weights : 50 kg
length (cm) : 75 cm

DMX CABLE

XLR 3M-3F



Cable : Twisted Pair
Shield 18 AWG
2C
Connector : XLR 3 pin
Male-Female
Length : 1/3/5/10 m

XLR 5M-5F



Cable : Twisted Pair
Shield 18 AWG
2C
Connector : XLR 5 pin
Male-Female
Length : 1/3/5/10 m

XLR 3M-5F



Cable : Twisted Pair
Shield 18 AWG
2C
Connector : XLR 3 pin Male
- 5 pin Female
Length : 0.3 m

XLR 5M-3F



Cable : Twisted Pair
Shield 18 AWG
2C
Connector : XLR 5 pin Male
- 3 pin Female
Length : 0.3 m

BEYOND TECHNOLOGY



BEYOND PRODUCTION



BEYOND STUDIO





HEAD OFFICE

LIGHTING AND EQUIPMENT
PUBLIC COMPANY LIMITED

539/2 16-17 Floor, Gypsum Metropolitan Tower,
Sri-Ayudhya Rd, Rajthevee, Bangkok 10400, Thailand.

Tax ID No. 0107547000338

(+66)2248-8133, (+66)2642-5092

(+66)2248-8144, (+66)2642-5091

E-mail to corporate communication

cco01@lighting.co.th

E-mail to oversea business

eklukb@lighting.co.th



FACTORY & WAREHOUSE

L&E MANUFACTURING
COMPANY LIMITED. (LEM)

85/3 Soi Prachumporn Chaengwattana Road,
Laksi, Bangkok 10210

(+66)2-982-4629

secretary.lem@gmail.com



L&E NOPPAWONG FACTORY

- L&E SOLID STATE CO.,LTD
- L&E MANUFACTURING CO.,LTD
- WAREHOUSE AND DISTRIBUTION CENTER

45/25-29 Moo 3 Bangbuothong-Supanburi
Road Namai Latlumkaeo, Pathumthani 12140

(+66)2 150 2601-4

(+66)2150 2605

secretaryled@lighting.co.th



Thailand offices

Lighting and Equipment Public Company Limited

Head Office

539/2, 16-17 Floor, Gypsum Metropolitan Tower,
Sri-Ayudhya Rd., Rajthevee, Bangkok 10400, Thailand.
Tel : (66) 0-2248-8133, (66) 0-2642-5092
Fax : (66) 0-2248-8144, (66) 0-2642-5091
E-mail to corporate communication : cco01@lighting.co.th
E-mail to oversea business: eklukb@lighting.co.th



L&E Head Office

Showroom

L&E : Lighting Solution Center
9, Pakin Building Ratchadapisek Road Dindaeng,
Bangkok, 10400
Tel : 662-246-1164-66, Fax : 662-246-1161
E-mail : rd@lighting.co.th
Rachapruok Branch 3rd Floor The Crystal SB Rachapruok
Tel : 02-118-7501
E-mail : rd@lighting.co.th



Lighting Solution Center
Rachapruok



Lighting Solution Center
Ratchadapisek

Oversea Offices and Contact



L&E Myanmar Co., Ltd.
No. 19-L Myint Zu 2 Street, Yankin
Township Between Kabaraye Pagoda Road
and Wayzayantar Road, Yangon, Myanmar.
E-mail : le_myanmar@lighting.co.th

Tel: +95 94 5001 0468



Lighting & Equipment (Vietnam) Co., Ltd.
Lot 101/3 Road No.1 Long Binh (AMATA)
Industrial Park, Long Binh Ward,
Bien Hoa City, Dong Nai Province, Vietnam
E-mail : eklukb@lighting.co.th

Tel: +84 251 368 5688



Lighting & Equipment (Representative Office) Indonesia.
The Vida Building 7th Floor,
Jl. Raya Perjuangan No.8
Kebon Jeruk-Jakarta Barat, Jakarta 11530
Indonesia
E-mail : jemmy@lighting.co.th

Tel: +62 212 977 8000
M: +62 818 08 2000 18
+62 818 08 3332 47



Representative of Lighting & Equipment Malaysia.
Contact point : Mr. Alex Goh
E-mail : alex.goh@lighting.co.th

M: +60 1 2286 1288



Lighting & Equipment Corporate showroom Cambodia
Home Access Co., Ltd.
THAN'S Building No.46
Mao Tse Toung Blvd (245) Corner 95 road,
Phnom Penh 120111, Cambodia
E-mail : sale@myhomeaccess.com

Tel: +855 23 216 195

